



Conecta

SALICE

Conecta - Concealed hinge



Concealed hinge • holder DQG3B



Concealed hinge • holder DQG5B

Conecta is the totally innovative Salice hinge that stands out for being completely hidden inside the door and the side of the cabinet, offering a concealed solution that enhances the aesthetics of the design. Its advanced technical characteristics allow it to manage the opening and the closing movements with precision and fluidity, even with large and heavy wooden and aluminium-framed doors.

The **Conecta** hinge is equipped with cam adjusters that allow precise adjustments in three directions: sideways, depth and height adjustment.



Bedroom • aluminium



Living room • aluminium

The 94° opening makes it particularly versatile.

Conecta is available in the version with an integrated soft close mechanism for a decelerated and silent closing.

Extremely versatile, **Conecta** can be used in cabinets with side thickness from 16 mm, while the two versions, for 22 mm thick doors or for 25 mm thick doors, both in wood and with aluminium frame, allow it to be used in every room of the house.

Conecta stands out for its refined aesthetics, which combines exclusive design details such as the customisable cover caps, available for both the door and the side of the cabinet, and the elegant nickel-plated and titanium finishes.

These aesthetic elements, combined with the high build quality, make it the ideal choice for applications that require not only high functionality but also a touch of class and sophistication.



Kitchen • wood

Conecta • Hinge for wooden doors

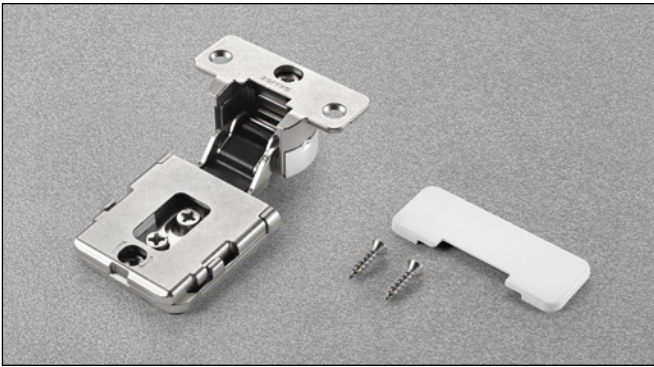

Concealed hinge with recessed insertion in the door and in the side.

Sideways adjustment -1 +2 mm
 Height adjustment -2,5 +2,5 mm
 Depth adjustment 0 +3 mm

Hinge part number nickel-plated finish	Hinge part number Titanium finish	Thickness of wooden doors	Door overlay on the side with holder DQG5	Door overlay on the side with holder DQG3
CQL3JE9	CQL3JE6	from 22 to 27 mm	10	12,5
CQL3KE9	CQL3KE6	from 22 to 27 mm	14	16,5
CQA3JE9	CQA3JE6	from 25 to 30 mm	10	12,5
CQA3KE9	CQA3KE6	from 25 to 30 mm	14	16,5

Approx. number of hinges required according to the door dimension and weight

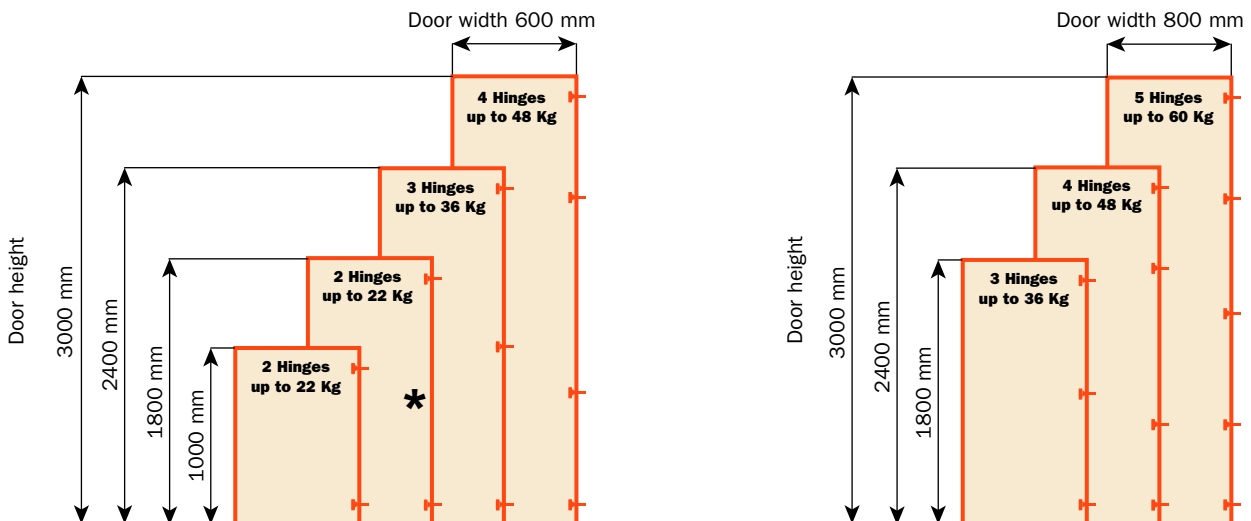

* The addition of one hinge improves the rigidity of the door and allows higher weights than indicated.

Conecta • Hinge for aluminium-framed doors



Concealed hinge with recessed insertion in the door and in the side.

Sideways adjustment -2 +0,5 mm
 Height adjustment -2,5 +2,5 mm
 Depth adjustment 0 +3 mm

Hinge part number nickel-plated finish	Hinge part number Titanium finish	Thickness of aluminium-framed doors	Door overlay on the side with holder DQG5	Door overlay on the side with holder DQG3
CQY3JE9	CQY3JE6	from 22 to 27 mm	10	12,5
CQY3KE9	CQY3KE6	from 22 to 27 mm	14	16,5
CQZ3JE9	CQZ3JE6	from 25 to 30 mm	10	12,5
CQZ3KE9	CQZ3KE6	from 25 to 30 mm	14	16,5

Approx. number of hinges required according to the door dimension and weight

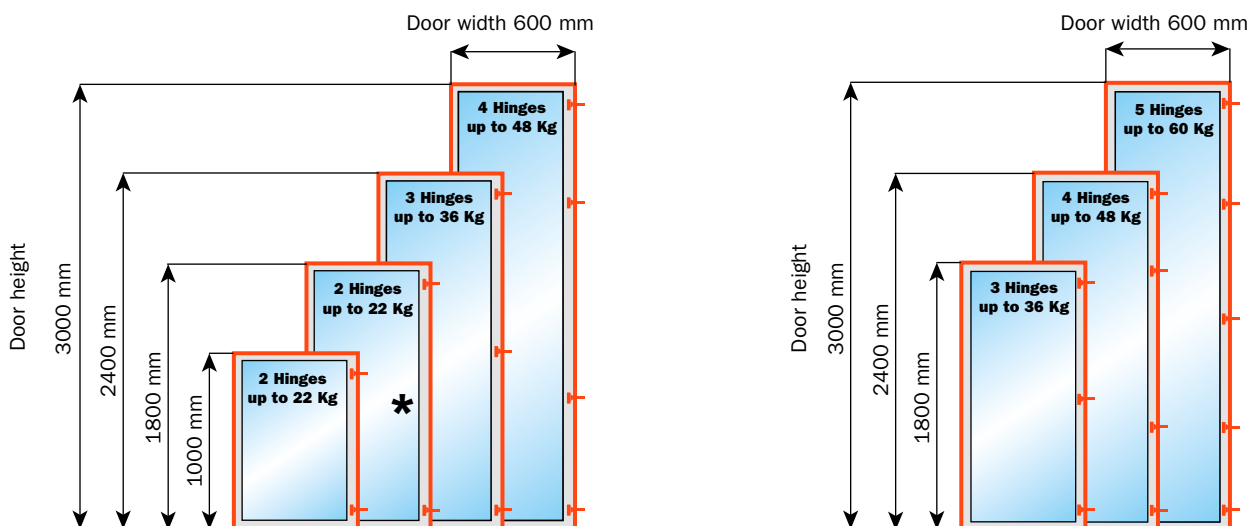

* The addition of one hinge improves the rigidity of the door and allows higher weights than indicated.

Conecta • Hinge for wooden doors

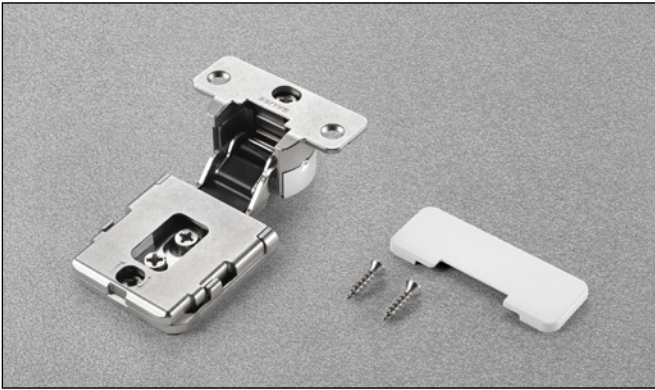

Technical features

Concealed Conecta hinge with recessed insertion in the door and in the side.

Rapid fixing of the door to the cabinet side
 Diameter 35 mm
 Drilling distance fixed at 10 mm from the edge of the door to the centre of the hole
 94° opening
 L = 3,5 mm

Depth of the metal cup:
CQL3JE: 19 mm (for doors from 22 mm)
CQA3JE: 22 mm (for doors from 25 mm)

Cup drilling depth and space needed to open the door

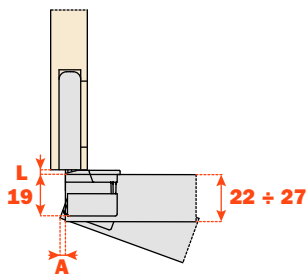

CQL3JE

T=	22	23	24	25	26	27
A=	2.4	3.1	4.0	4.7	5.5	6.3

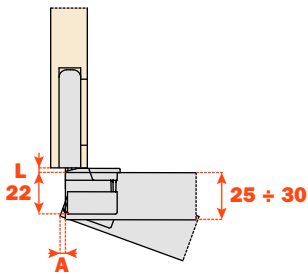

CQA3JE

T=	25	26	27	28	29	30
A=	2.4	3.1	4.0	4.7	5.5	6.3

Assembly instructions

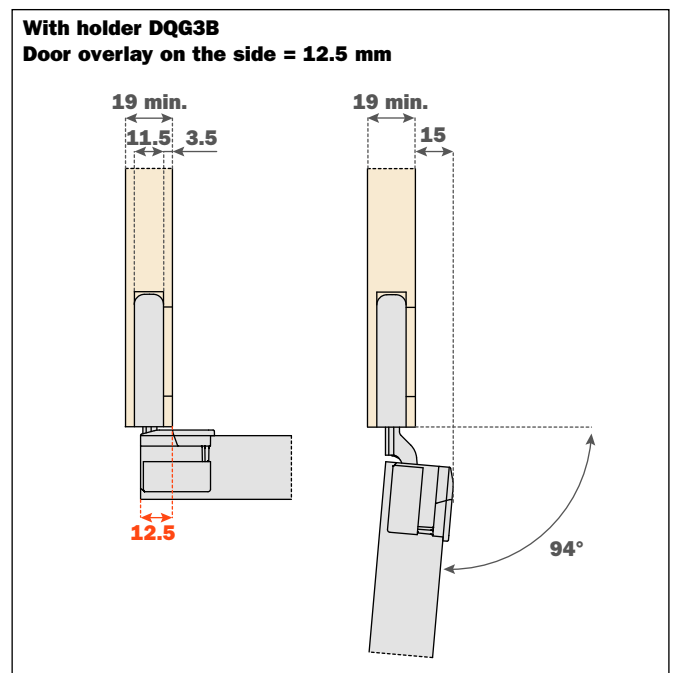
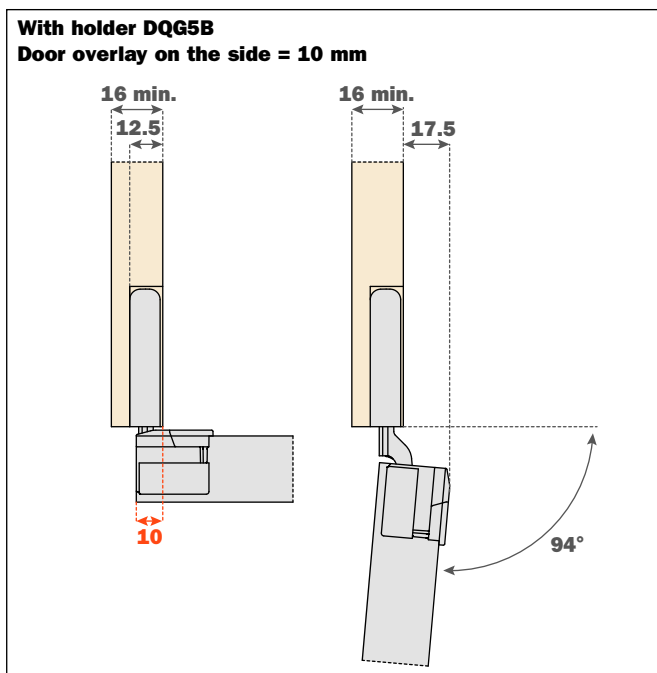

Workings on door and cabinet

Holder DQG5B



- For single application on side thickness 16 mm min.
- For double application on side thickness 25 mm

To be screw-fixed to the cabinet side:

- Single application with Euroscrews, drilling $\varnothing 5 \times 12.5$ mm
- Double application with $\varnothing 5$ mm interscrews
- Fixing screws and cover caps included in the single packing
- Fixing screws included in the industrial packing

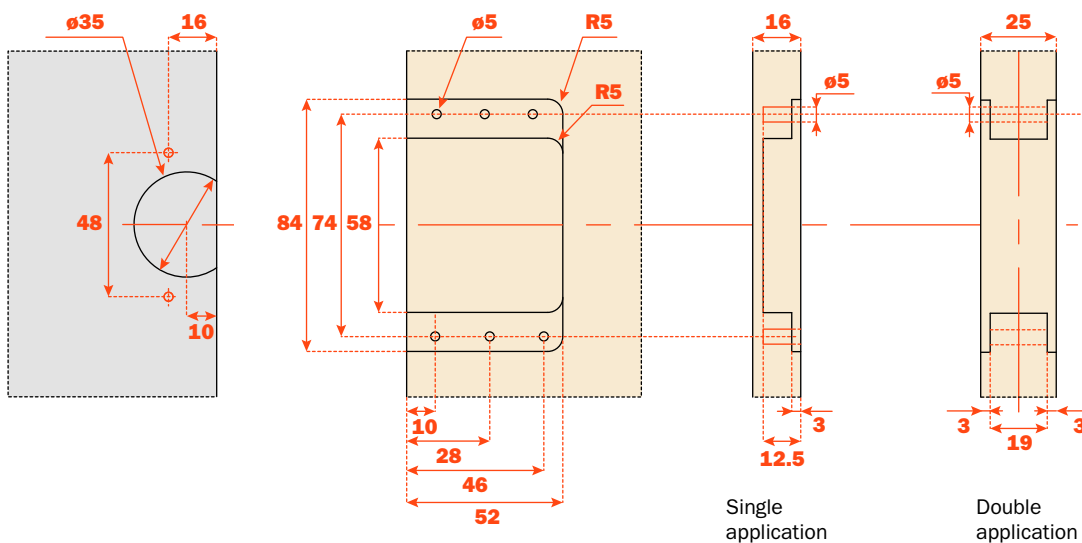

Holder DQG3B

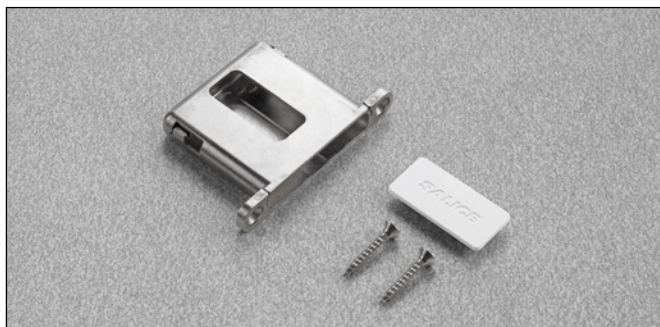

- For single application on side thickness 19 mm min.
- For double application on side thickness 30 mm

To be screw-fixed to the cabinet side:

- Single and double application with screws $\varnothing 4 \times 25$ mm
- Fixing screws and cover caps included in the single packing
- Fixing screws included in the industrial packing

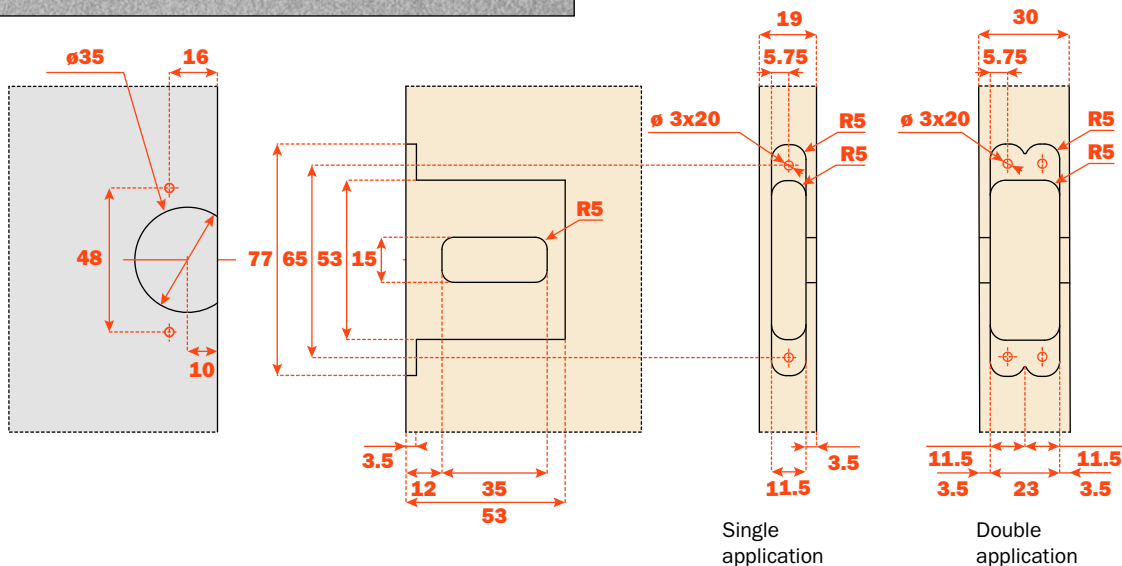

Conecta • Hinge for wooden doors

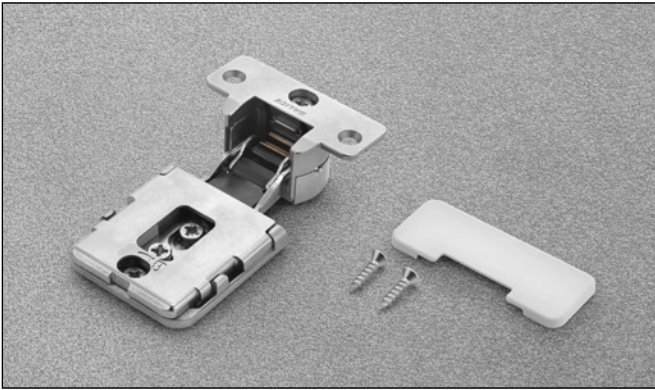

Technical features

Concealed Conecta hinge with recessed insertion in the door and in the side.

Rapid fixing of the door to the cabinet side
 Diameter 35 mm
 Drilling distance fixed at 10 mm from the edge of the door to the centre of the hole
 94° opening
 L = 3,5 mm

Depth of the metal cup:
CQL3KE: 19 mm (for doors from 22 mm)
CQA3KE: 22 mm (for doors from 25 mm)

Cup drilling depth and space needed to open the door

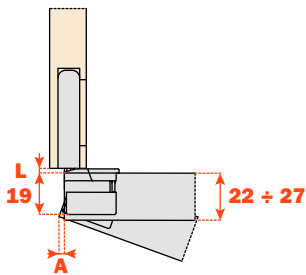

CQL3KE

T=	22	23	24	25	26	27
A=	2.4	3.1	4.0	4.7	5.5	6.3

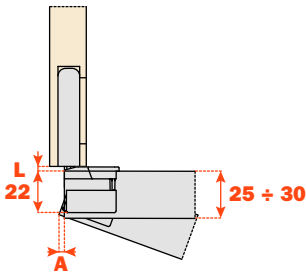

CQA3KE

T=	25	26	27	28	29	30
A=	2.4	3.1	4.0	4.7	5.5	6.3

Assembly instructions

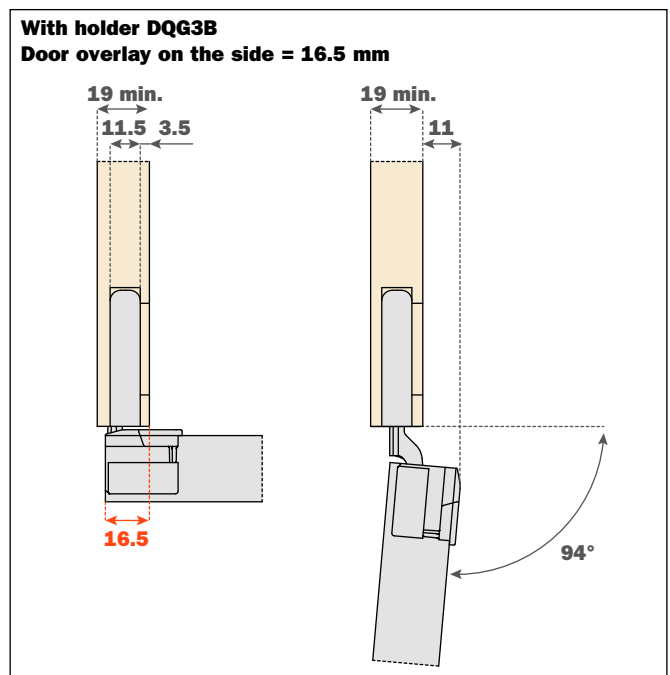
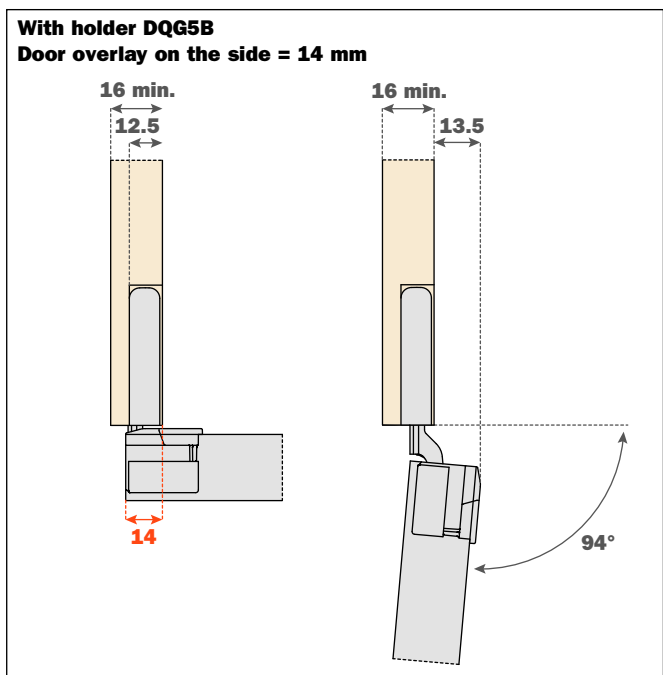

Workings on door and cabinet

Holder DQG5B

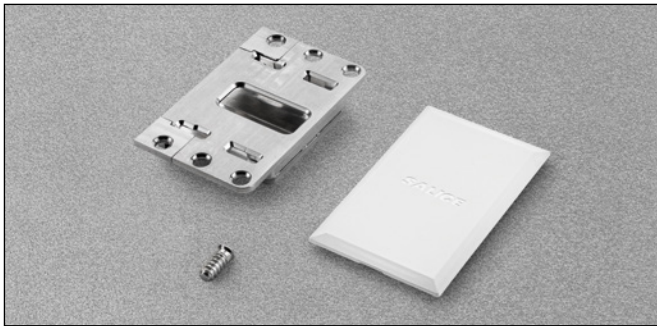

- For single application on side thickness 16 mm min.

To be screw-fixed to the cabinet side:

- Single application with Euroscrews, drilling $\varnothing 5 \times 12.5$ mm
- Fixing screws and cover caps included in the single packing
- Fixing screws included in the industrial packing

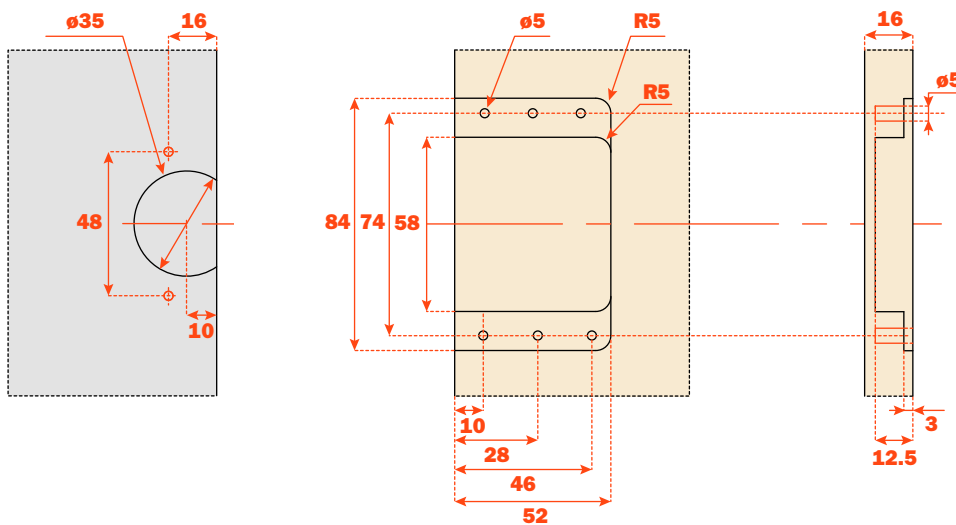

Holder DQG3B

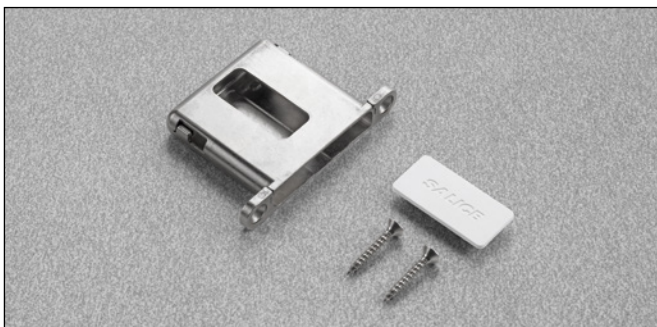

- For single application on side thickness 19 mm min.

To be screw-fixed to the cabinet side:

- Single application with screws $\varnothing 4 \times 25$ mm
- Fixing screws and cover caps included in the single packing
- Fixing screws included in the industrial packing

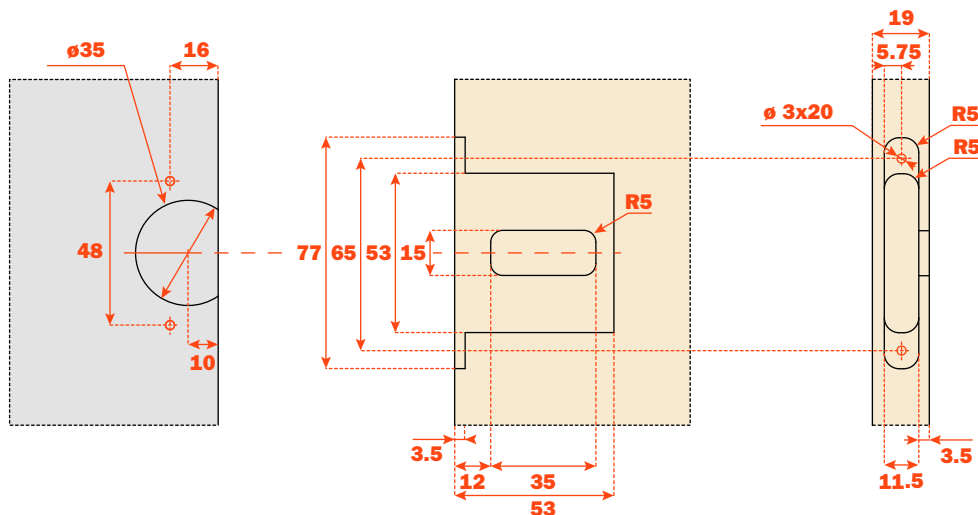

Conecta • Hinge for aluminium-framed doors

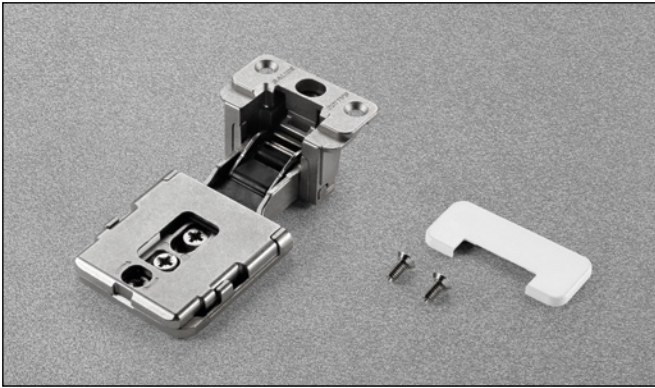

Technical features

Concealed Conecta hinge with recessed insertion in the door and in the side.

Rapid fixing of the door to the cabinet side
 For aluminium-framed doors
 94° opening
 L = 3,5 mm

Depth of the metal cup:
CQY3JE: 21 mm

Cup drilling depth and space needed to open the door

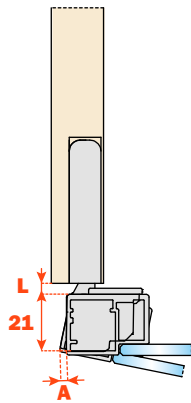

T=	22	23	24	25	26	27
A=	2.4	3.1	4.0	4.7	5.5	6.3

Assembly instructions

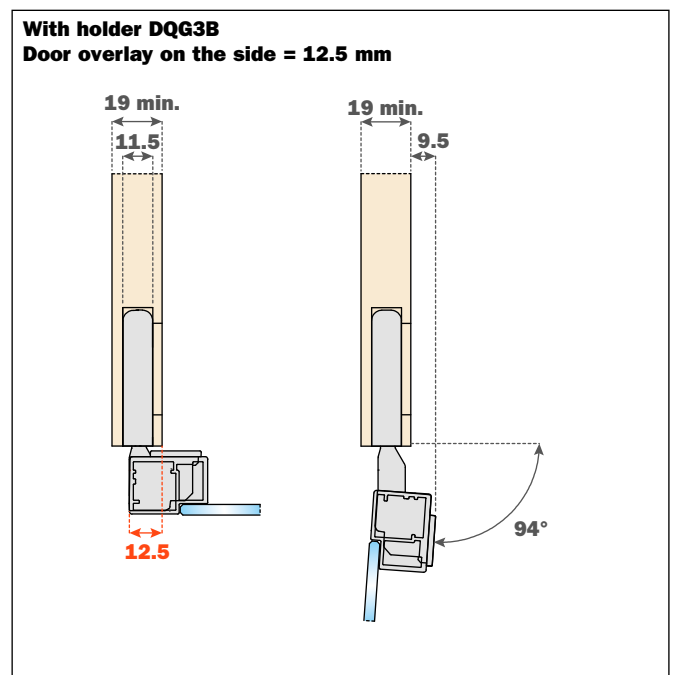
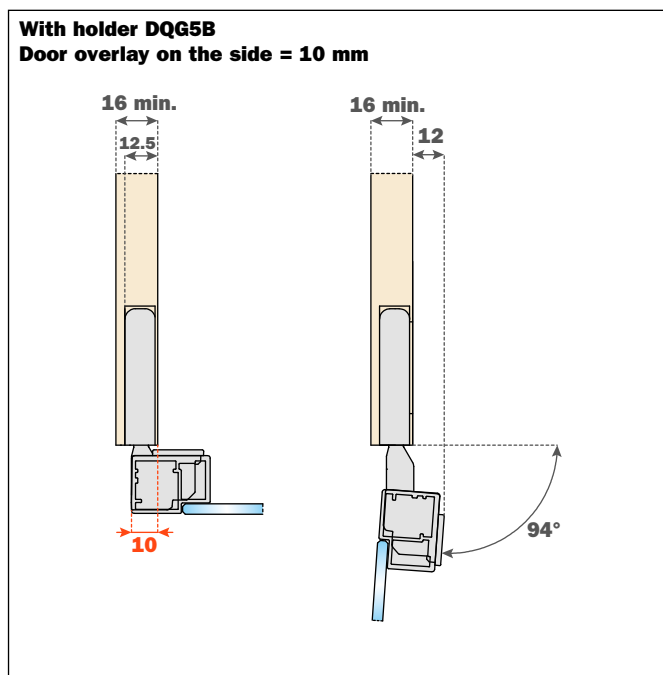

Conecta • Hinge for aluminium-framed doors



Technical features

Concealed Conecta hinge with recessed insertion in the door and in the side.

Rapid fixing of the door to the cabinet side

For aluminium-framed doors

94° opening

L = 3,5 mm

Depth of the metal cup:

CQY3KE: 21 mm

Cup drilling depth and space needed to open the door

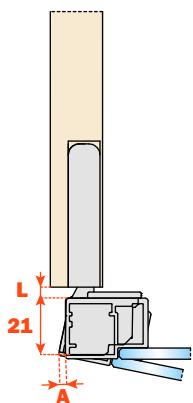

T=	22	23	24	25	26	27
A=	2.4	3.1	4.0	4.7	5.5	6.3

Assembly instructions

With holder DQG5B
Door overlay on the side = 14 mm

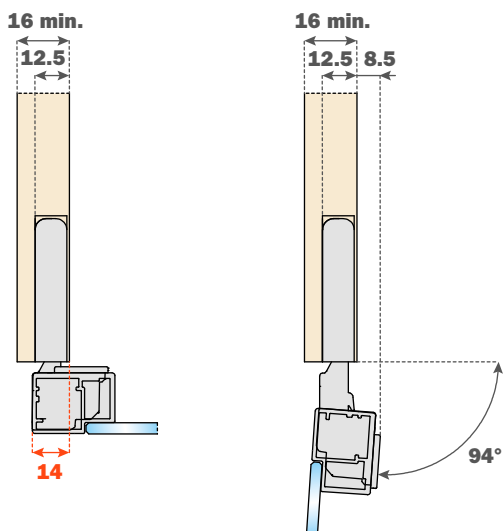

With holder DQG3B
Door overlay on the side = 16.5 mm

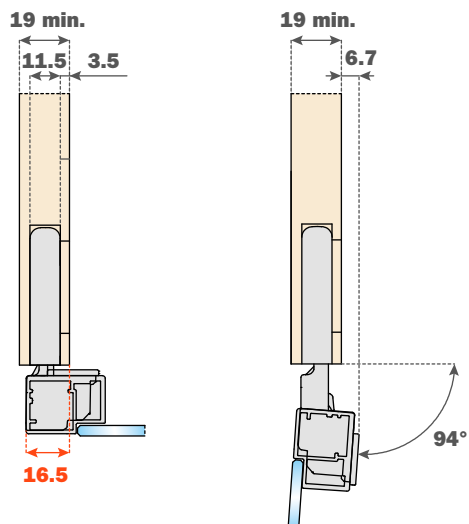

Conecta • Hinge for aluminium-framed doors

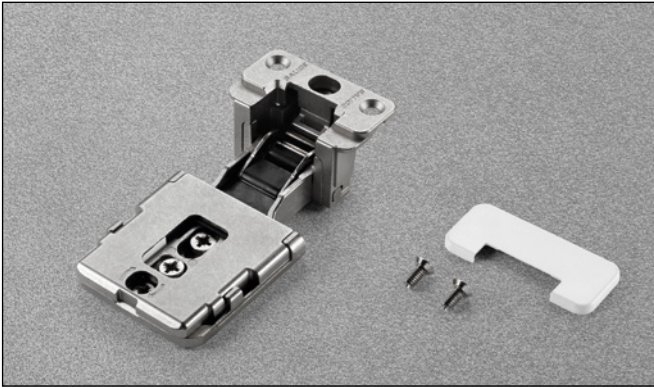

Technical features

Concealed Conecta hinge with recessed insertion in the door and in the side.

Rapid fixing of the door to the cabinet side
 For aluminium-framed doors
 94° opening
 L = 3,5 mm

Depth of the metal cup:
CQZ3JE: 24 mm

Cup drilling depth and space needed to open the door

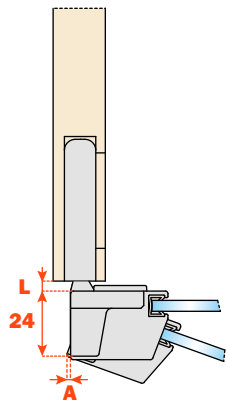

T=	25	26	27	28	29	30
A=	2.4	3.3	4.2	5.2	6.1	7.1

Assembly instructions

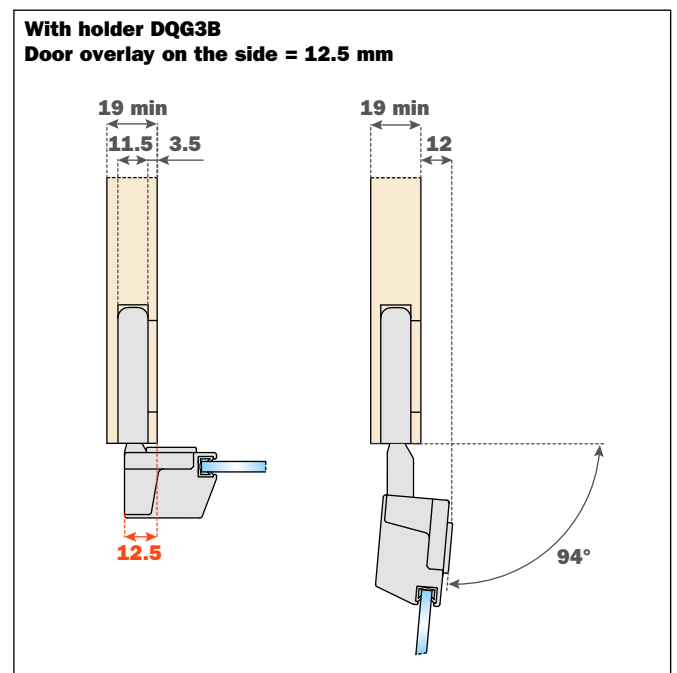
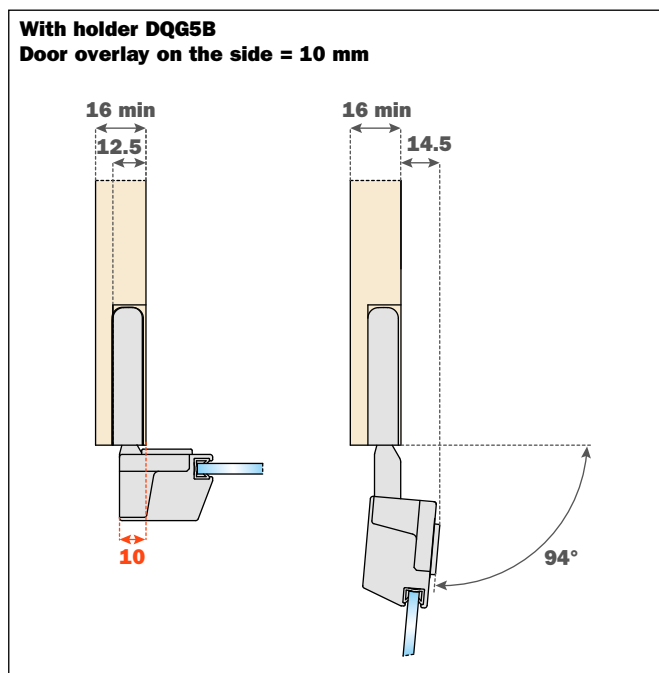

Conecta • Hinge for aluminium-framed doors



Technical features

Concealed Conecta hinge with recessed insertion in the door and in the side.

Rapid fixing of the door to the cabinet side
 For aluminium-framed doors
 94° opening
 L = 3,5 mm

Depth of the metal cup:
CQZ3KE: 24 mm

Cup drilling depth and space needed to open the door

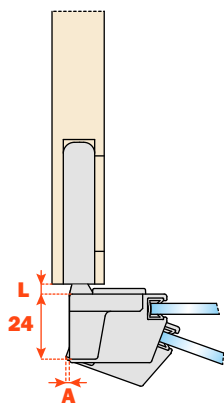

T=	25	26	27	28	29	30
A=	2.4	3.3	4.2	5.2	6.1	7.1

Assembly instructions

With holder DQG5B
 Door overlay on the side = 14 mm

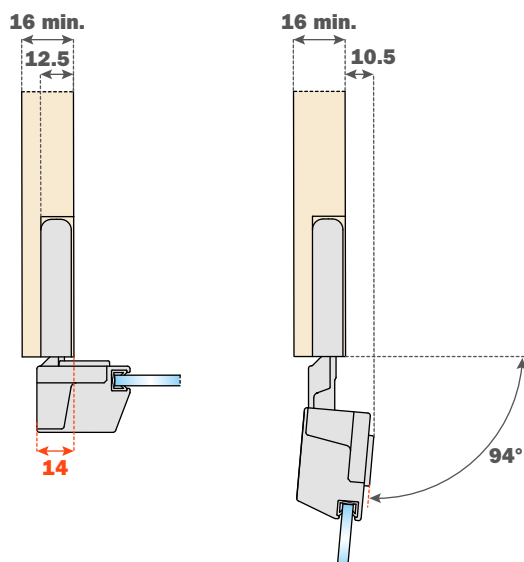

With holder DQG3B
 Door overlay on the side = 16.5 mm

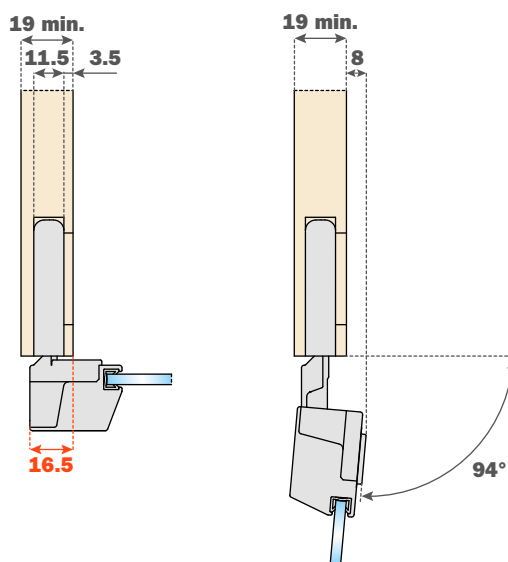

Workings on door and cabinet

Holder DQG5B



- For single application on side thickness 16 mm min.
- For double application on side thickness 25 mm

To be screw-fixed to the cabinet side:

- Single application with Euroscrews, drilling $\varnothing 5 \times 12.5$ mm
- Double application with $\varnothing 5$ mm interscrews
- Fixing screws and cover caps included in the single packing
- Fixing screws included in the industrial packing

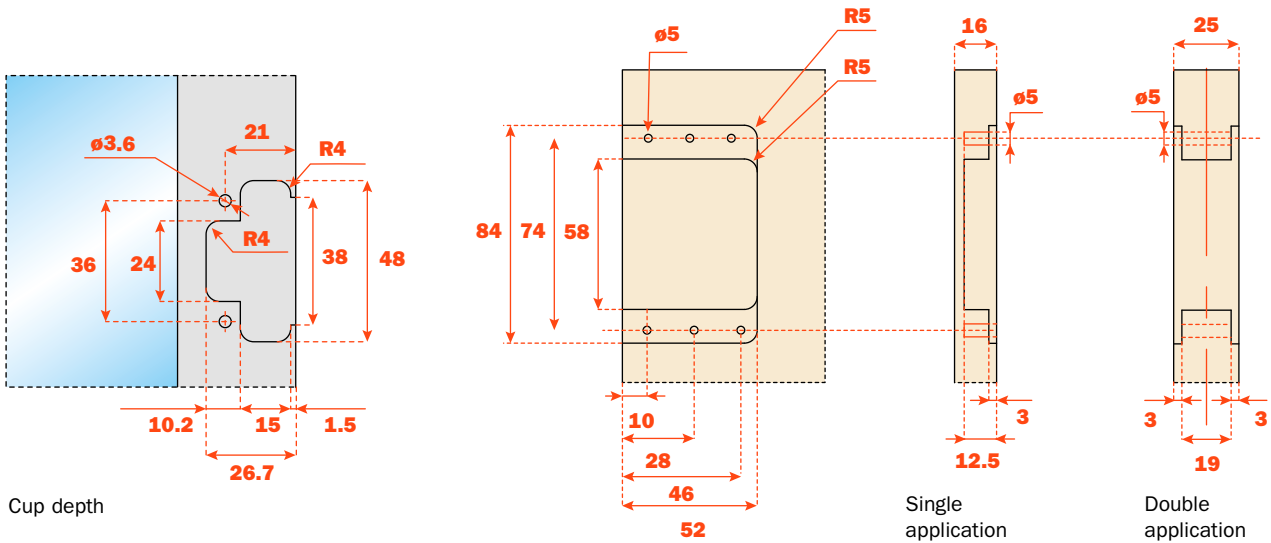

* Cup depth

Holder DQG3B

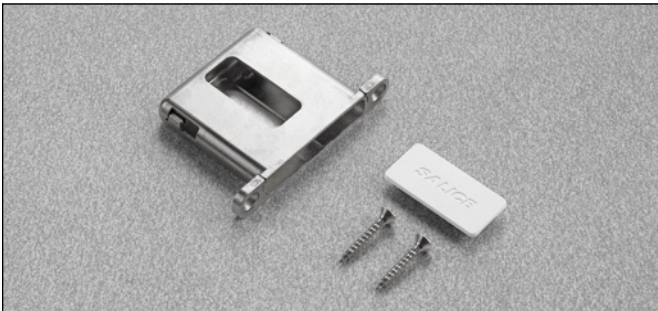

- For single application on side thickness 19 mm min.
- For double application on side thickness 30 mm

To be screw-fixed to the cabinet side:

- Single and double application with screws $\varnothing 4 \times 25$ mm
- Fixing screws and cover caps included in the single packing
- Fixing screws included in the industrial packing

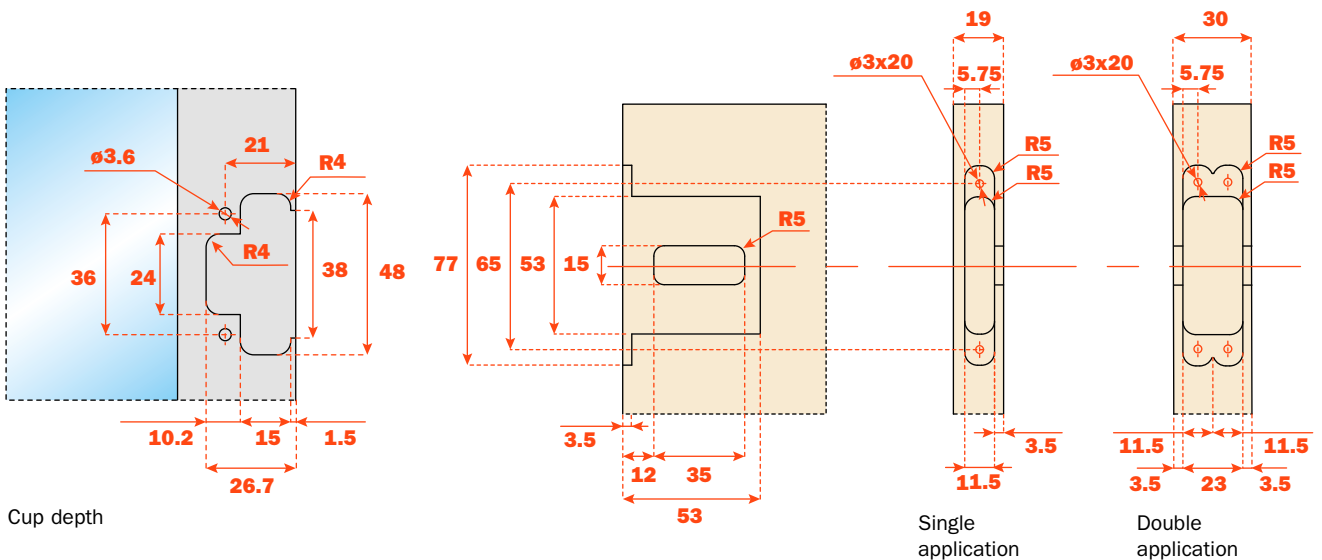

* Cup depth

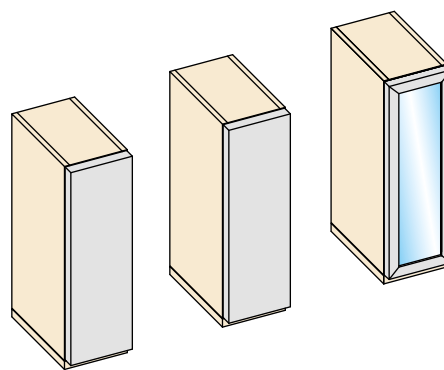

Assembly and adjustments

Conecta • Assembly • Single application with independent structures, holder DQG5B

Fix the holder to the cabinet side using the Euro screws

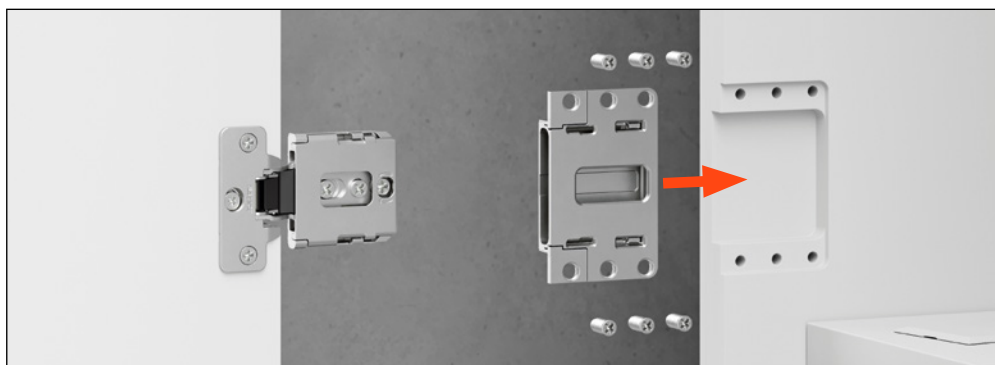

Fully insert the hinge into the holder

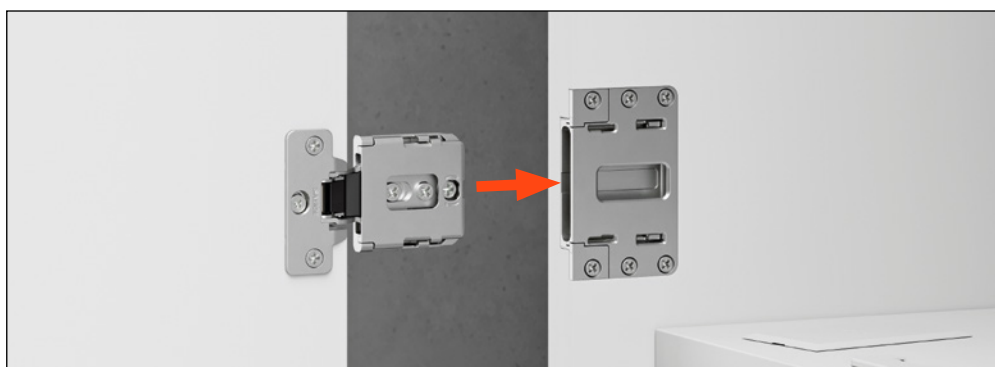

Once fully inserted, lock the hinge into place using the back cam

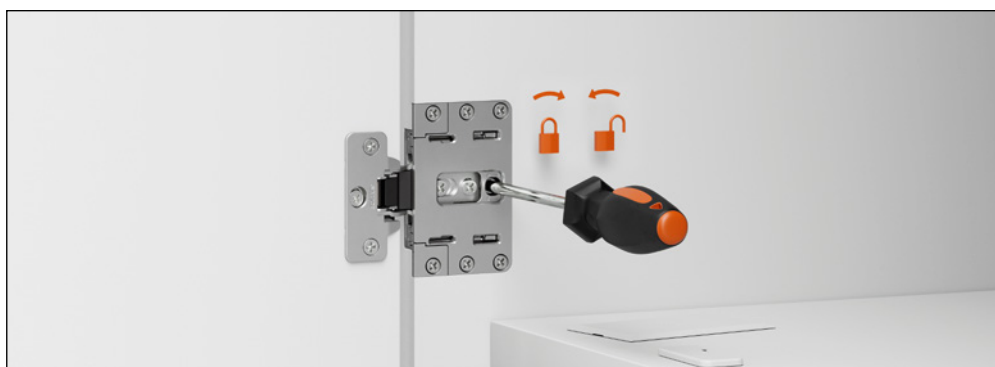

Apply the flange and the screw cover caps



Application with double side, holder DQG5B

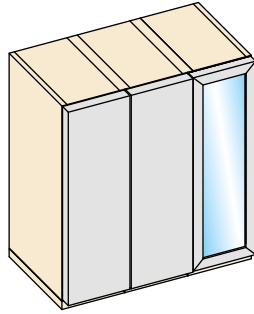

Fix the holders to the cabinet side using the interscrews



Fully insert the hinges into the holders

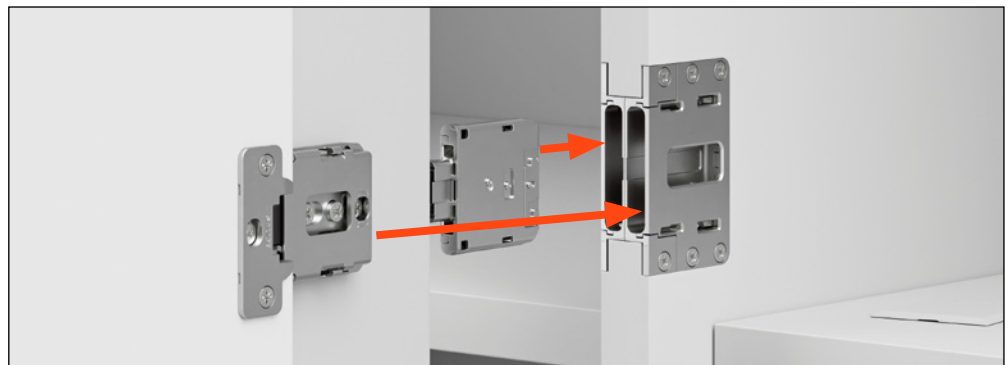

Once fully inserted, lock the hinges into place using the back cam



Apply the flange and the screw cover caps

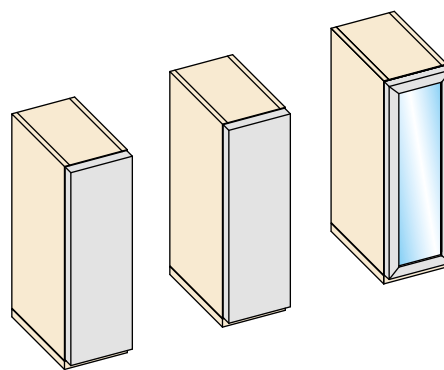
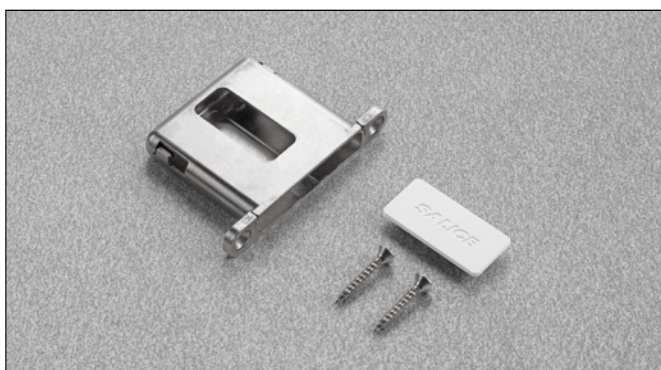

Conecta • Assembly • Single application with independent structures, holder DQG3B

Fix the holder to the cabinet side using the woodscrews

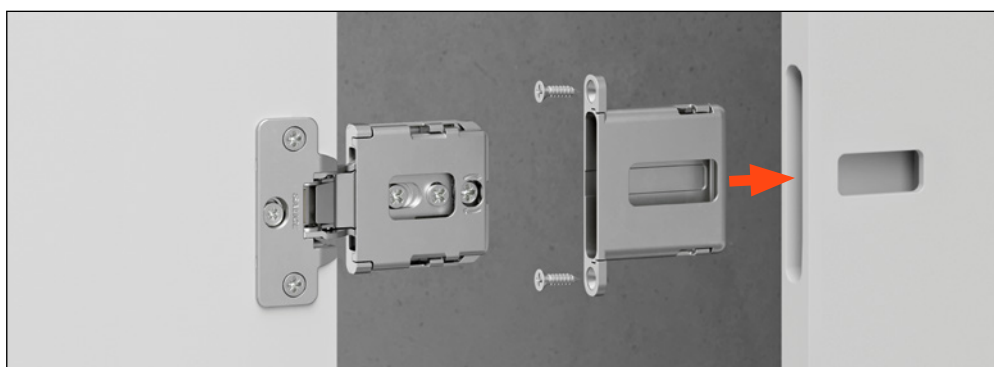

Fully insert the hinge into the holder

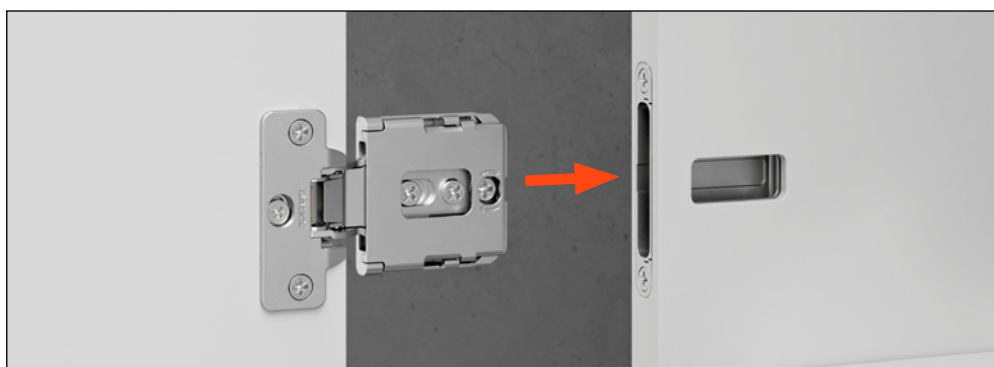

Once fully inserted, lock the hinge into place using the back cam

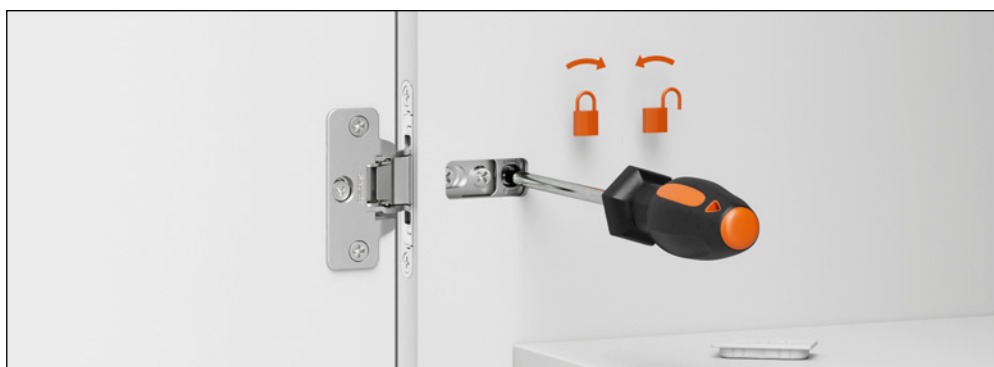

Apply the flange and the screw cover caps



Application with double side, holder DQG3B

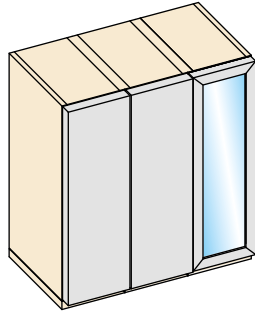

Fix the holders to the cabinet side using the woodscrews

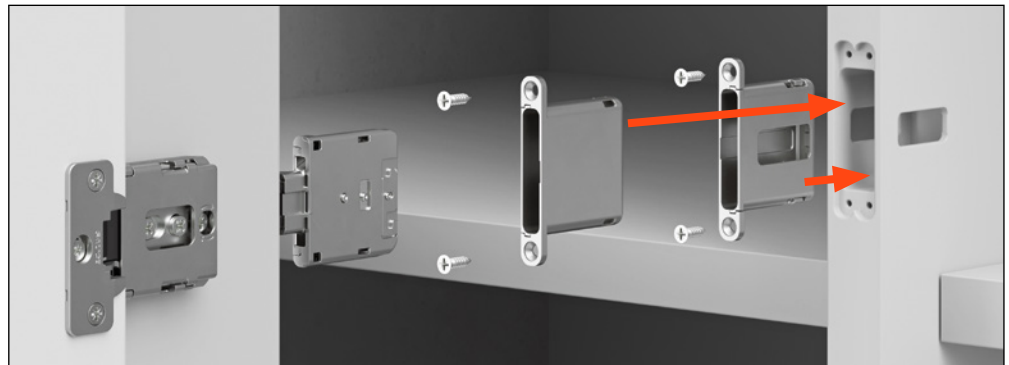

Fully insert the hinges into the holders

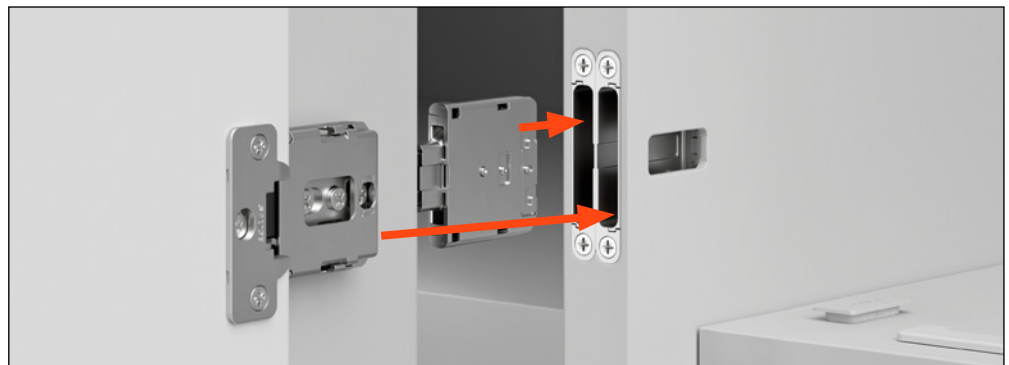

Once fully inserted, lock the hinges into place using the back cam

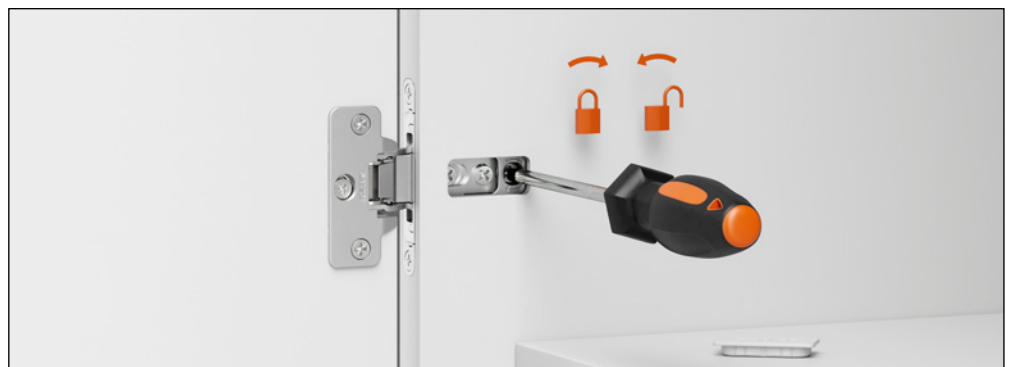

Apply the flange and the screw cover caps



Conecta • Adjustments • Holder DQG5B

Sideways adjustment for hinge
for wooden doors:
from -1 to +2

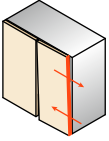

Sideways adjustment for hinge
for aluminium-framed doors:
from -2 to +0,5

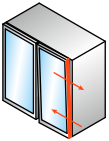

Height adjustment for hinge
for wooden doors:
from -2,5 to +2,5

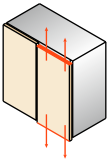

Height adjustment for hinge
for aluminium-framed doors:
from -2,5 to +2,5

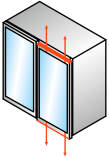

Depth adjustment for hinge
for wooden doors:
from 0 to +3

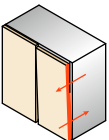

Depth adjustment for hinge
for aluminium-framed doors:
from 0 to +3

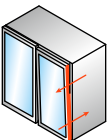

Holder DQG3B

Sideways adjustment for hinge
for wooden doors:
from -1 to +2

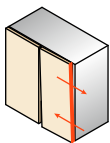

Sideways adjustment for hinge
for aluminium-framed doors:
from -2 to +0,5

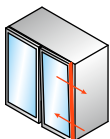

Height adjustment for hinge
for wooden doors:
from -2,5 to +2,5

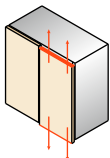

Height adjustment for hinge
for aluminium-framed doors:
from -2,5 to +2,5

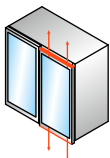



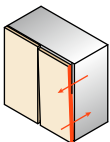

Depth adjustment for hinge
for wooden doors:
from 0 to +3

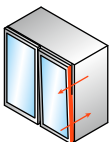



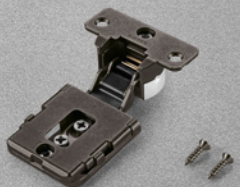
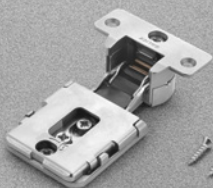
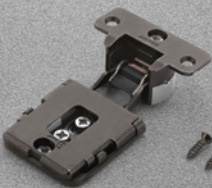
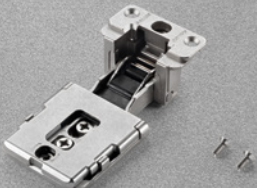
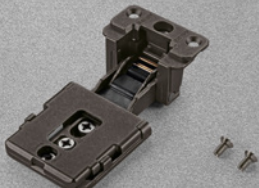
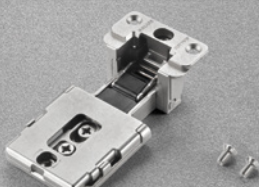
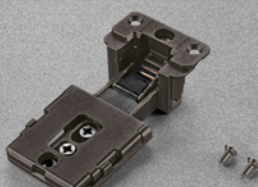



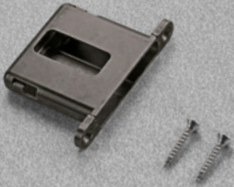

Depth adjustment for hinge
for aluminium-framed doors:
from 0 to +3

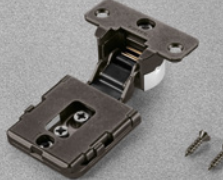
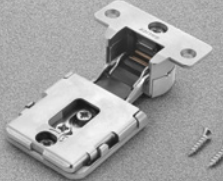

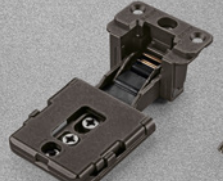

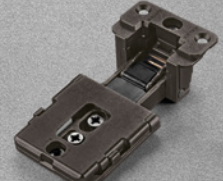

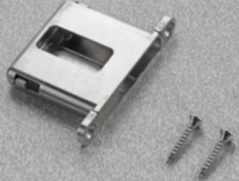
Conecta for 22 mm thick doors • Industrial packing

Hinge with Nickel-plated finish	Hinge with Titanium finish	INDUSTRIAL packing
For wooden doors • Door overlay: 10 mm (DQG5) - 12,5 mm (DQG3)		
CQL3JE9XXI	CQL3JE6XXI	
		
For wooden doors • Door overlay: 14 mm (DQG5) - 16,5 mm (DQG3)		
CQL3KE9XXI	CQL3KE6XXI	
		
For aluminium-framed doors • Door overlay: 10 mm (DQG5) - 12,5 mm (DQG3)		
CQY3JE9XXI	CQY3JE6XXI	
		
For aluminium-framed doors • Door overlay: 14 mm (DQG5) - 16,5 mm (DQG3)		
CQY3KE9XXI	CQY3KE6XXI	
		
Holder with Nickel-plated finish	Holder with Titanium finish	INDUSTRIAL packing
DQG5BX9XI	DQG5BX6XI	
		Boxes 100 pcs. Pallets 24 boxes • Fixing screws included
Holder with Nickel-plated finish	Holder with Titanium finish	INDUSTRIAL packing
DQG3BX9XI	DQG3BX6XI	
		Boxes 100 pcs. Pallets 24 boxes • Fixing screws included

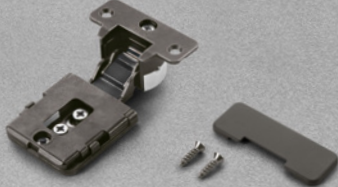

Conecta for 25 mm thick doors • Industrial packing

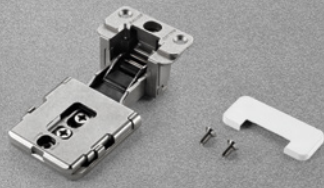
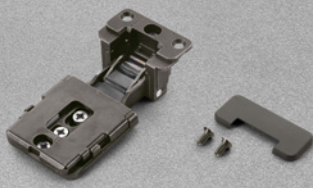
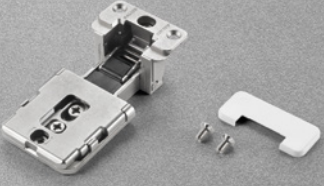
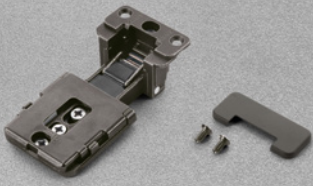
Hinge with Nickel-plated finish	Hinge with Titanium finish	INDUSTRIAL packing
For wooden doors • Door overlay: 10 mm (DQG5) - 12,5 mm (DQG3)		
CQA3JE9XXI	CQA3JE6XXI	
		
For wooden doors • Door overlay: 14 mm (DQG5) - 16,5 mm (DQG3)		
CQA3KE9XXI	CQA3KE6XXI	
		
For aluminium-framed doors • Door overlay: 10 mm (DQG5) - 12,5 mm (DQG3)		
CQZ3JE9XXI	CQZ3JE6XXI	
		
For aluminium-framed doors • Door overlay: 14 mm (DQG5) - 16,5 mm (DQG3)		
CQZ3KE9XXI	CQZ3KE6XXI	
		
		Boxes 100 pcs. Pallets 24 boxes • Fixing screws included
Holder with Nickel-plated finish	Holder with Titanium finish	INDUSTRIAL packing
DQG5BX9XI	DQG5BX6XI	
		
		Boxes 100 pcs. Pallets 24 boxes • Fixing screws included
Holder with Nickel-plated finish	Holder with Titanium finish	INDUSTRIAL packing
DQG3BX9XI	DQG3BX6XI	
		
		Boxes 100 pcs. Pallets 24 boxes • Fixing screws included

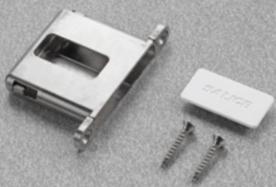
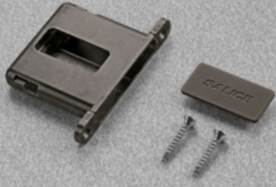
Conecta for 22 mm thick doors • Single packing



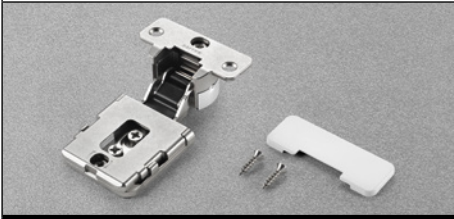
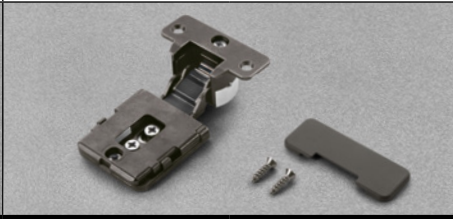
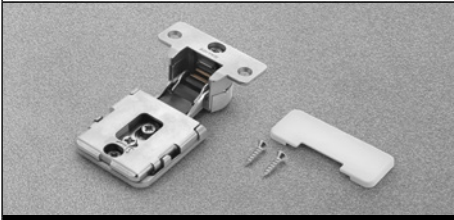
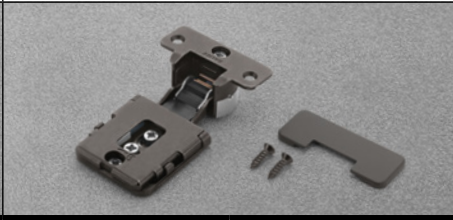
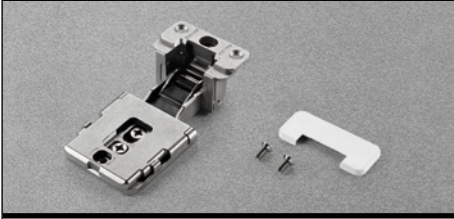
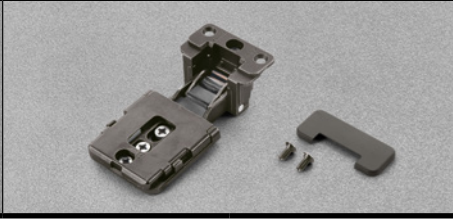
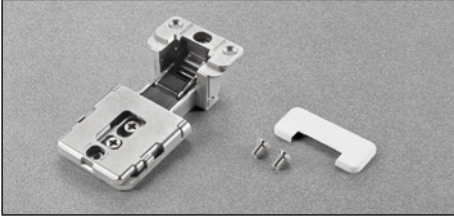
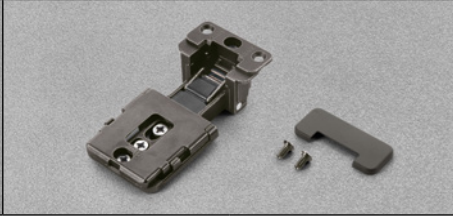

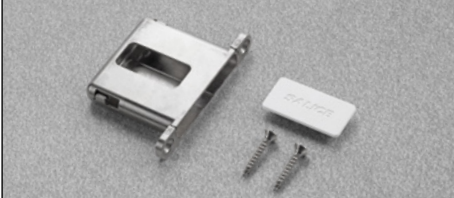
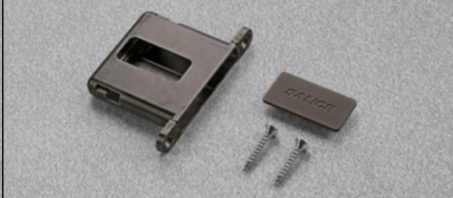





Hinge with Nickel-plated finish	Hinge with Titanium finish	SINGLE packing
For wooden doors • Door overlay: 10 mm (DQG5) - 12,5 mm (DQG3)		
CQL3JE9XXV	CQL3JE6XXV	
		
For wooden doors • Door overlay: 14 mm (DQG5) - 16,5 mm (DQG3)		
CQL3KE9XXV	CQL3KE6XXV	
		
For aluminium-framed doors • Door overlay: 10 mm (DQG5) - 12,5 mm (DQG3)		
CQY3JE9XXV	CQY3JE6XXV	
		
For aluminium-framed doors • Door overlay: 14 mm (DQG5) - 16,5 mm (DQG3)		
CQY3KE9XXV	CQY3KE6XXV	
		
CQL3JE9XXV	CQL3JE6XXV	Bags 2 pcs. Boxes with 25 bags Pallets 24 boxes • Fixing screws and flange cover cap included
CQL3KE9XXV	CQL3KE6XXV	
CQY3JE9XXV	CQY3JE6XXV	
CQY3KE9XXV	CQY3KE6XXV	
Holder with Nickel-plated finish	Holder with Titanium finish	SINGLE packing
DQG5BX9XS	DQG5BX6XS	
		Bags 2 pcs. Boxes with 25 bags Pallets 24 boxes • Fixing screws and screw cover cap included
DQG3BX9XS	DQG3BX6XS	
		Bags 2 pcs. Boxes with 25 bags Pallets 24 boxes • Fixing screws and screw cover cap included

Conecta for 25 mm thick doors • Single packing

Hinge with Nickel-plated finish	Hinge with Titanium finish	SINGLE packing
For wooden doors • Door overlay: 10 mm (DQG5) - 12,5 mm (DQG3)		
CQA3JE9XXV	CQA3JE6XXV	
		
For wooden doors • Door overlay: 14 mm (DQG5) - 16,5 mm (DQG3)		
CQA3KE9XXV	CQA3KE6XXV	
		
For aluminium-framed doors • Door overlay: 10 mm (DQG5) - 12,5 mm (DQG3)		
CQZ3JE9XXV	CQZ3JE6XXV	
		
For aluminium-framed doors • Door overlay: 14 mm (DQG5) - 16,5 mm (DQG3)		
CQZ3KE9XXV	CQZ3KE6XXV	
		
		<p>Bags 2 pcs. Boxes with 25 bags Pallets 24 boxes</p> <p>•</p> <p>Fixing screws and flange cover cap included</p>
Holder with Nickel-plated finish	Holder with Titanium finish	SINGLE packing
DQG5BX9XS	DQG5BX6XS	
		
		<p>Bags 2 pcs. Boxes with 25 bags Pallets 24 boxes</p> <p>•</p> <p>Fixing screws and screw cover cap included</p>
Holder with Nickel-plated finish	Holder with Titanium finish	SINGLE packing
DQG3BX9XS	DQG3BX6XS	
		
		<p>Bags 2 pcs. Boxes with 25 bags Pallets 24 boxes</p> <p>•</p> <p>Fixing screws and screw cover cap included</p>

Conecta - Screw cover caps with Salice printed logo









Symmetrical plastic screw cover caps with Salice printed logo.



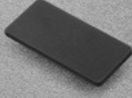

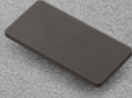
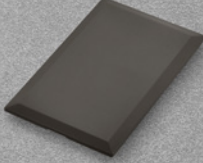

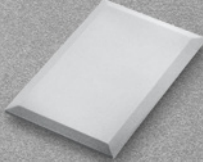



Screw cover caps DQG3B	Screw cover caps DQG5B	Packing
PQFXAA1SN	PQF5AA1SN	Boxes 100 pcs. • Large Boxes 600 pcs.
White	White	
		
PQFXAA3SN	PQF5AA3SN	Boxes 100 pcs. • Large Boxes 600 pcs.
Black	Black	
		
PQFXAA6SN	PQF5AA6SN	Boxes 100 pcs. • Large Boxes 600 pcs.
Titanium	Titanium	
		
PQFXAA9SN	PQF5AA9SN	Boxes 100 pcs. • Large Boxes 600 pcs.
Satin Chrome	Satin Chrome	
		
PQFXAAWSN	PQF5AAWSN	Boxes 100 pcs. • Large Boxes 600 pcs.
Satin Gold	Satin Gold	
		

Screw cover caps and flange cover caps

Symmetrical plastic screw cover caps. They can be personalised on request with silk-screen printed logo.

Plastic flange cover caps.

Screw cover caps DQG3B	Screw cover caps DQG5B	Packing
PQFXAA1	PQF5AA1	Boxes 100 pcs. • Large Boxes 600 pcs.
White	White	
		
PQFXAA3	PQF5AA3	Boxes 100 pcs. • Large Boxes 600 pcs.
Black	Black	
		
PQFXAA6	PQF5AA6	Boxes 100 pcs. • Large Boxes 600 pcs.
Titanium	Titanium	
		
PQFXAA9	PQF5AA9	Boxes 100 pcs. • Large Boxes 600 pcs.
Satin Chrome	Satin Chrome	
		
PQFXAAW	PQF5AAW	Boxes 100 pcs. • Large Boxes 600 pcs.
Satin Gold	Satin Gold	
		

Flange cover caps Hinge for wooden doors	Flange cover caps Hinge for aluminium-framed doors	Packing
PQSAAA1	PQSZAA1	Boxes 100 pcs. • Large Boxes 600 pcs.
White	White	
		
PQSAAA3	PQSZAA3	Boxes 100 pcs. • Large Boxes 600 pcs.
Black	Black	
		
PQSAAA6	PQSZAA6	Boxes 100 pcs. • Large Boxes 600 pcs.
Titanium	Titanium	
		
PQSAAA9	PQSZAA9	Boxes 100 pcs. • Large Boxes 600 pcs.
Satin Chrome	Satin Chrome	
		
PQSAAAW	PQSZAAW	Boxes 100 pcs. • Large Boxes 600 pcs.
Satin Gold	Satin Gold	
		

Conecta - Accessories

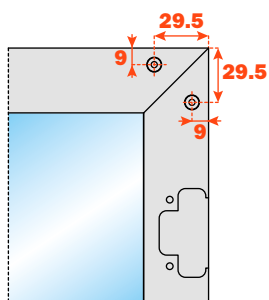

Steel corner connectors for the assembly of the aluminium door profile	Part number	Packing
	DQZ3HS5V04	<p>Boxes with 25 bags</p> <p>1 bag contains: 4 corner connectors and assembly screws (nickel-plated and titanium finish)</p>

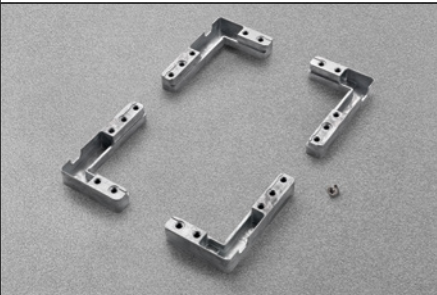

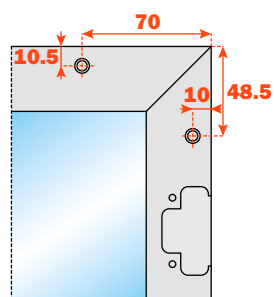
Die-cast corner connectors for the assembly of the aluminium door profile	Part number	Packing
	DEL6BSFV02	<p>Boxes with 25 bags</p> <p>1 bag contains: 4 corner connectors and assembly screws (nickel-plated and titanium finish)</p>



Gasket for glass	Part number	Packing	Length
	DQZ6AG3000T	100 lengths	3 metres

Aluminium door profile for glass insertion (4 mm)	Part number	Packing	Length
	DQZ6LP300P	10 profiles in Anodised Aluminium	3 metres
	DQZ6LP300T	10 profiles in Titanium finish	
	DQZ6LF300P	10 profiles in Anodised Aluminium with handle	
	DQZ6LF300T	10 profiles in Titanium finish with handle	

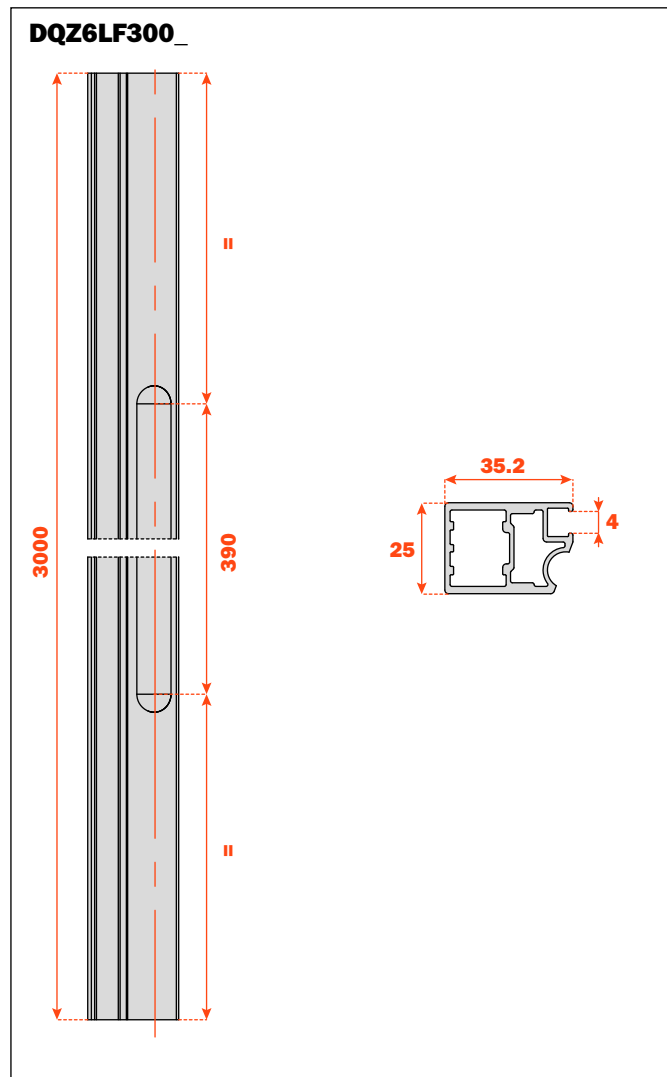
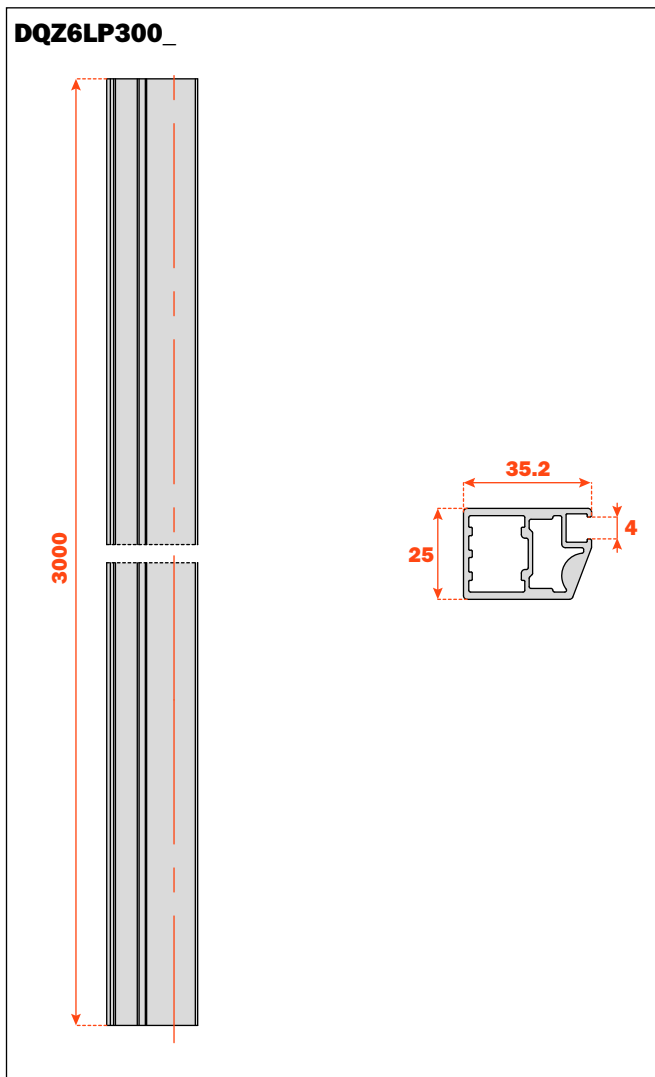
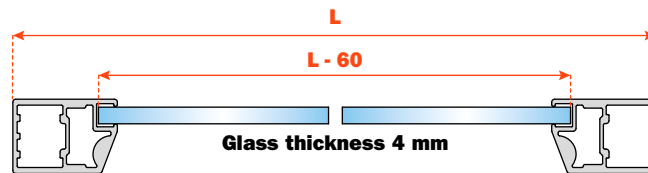

Conecta - Accessories

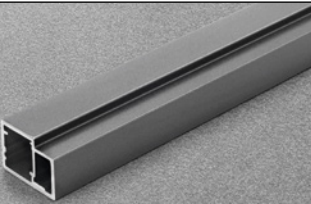
Aluminium door profile for glass to be glued (4 mm)	Part number	Packing	Length
	DQY9LP300P	10 profiles in Anodised Aluminium	3 metres
	DQY9LP300T	10 profiles in Titanium finish	

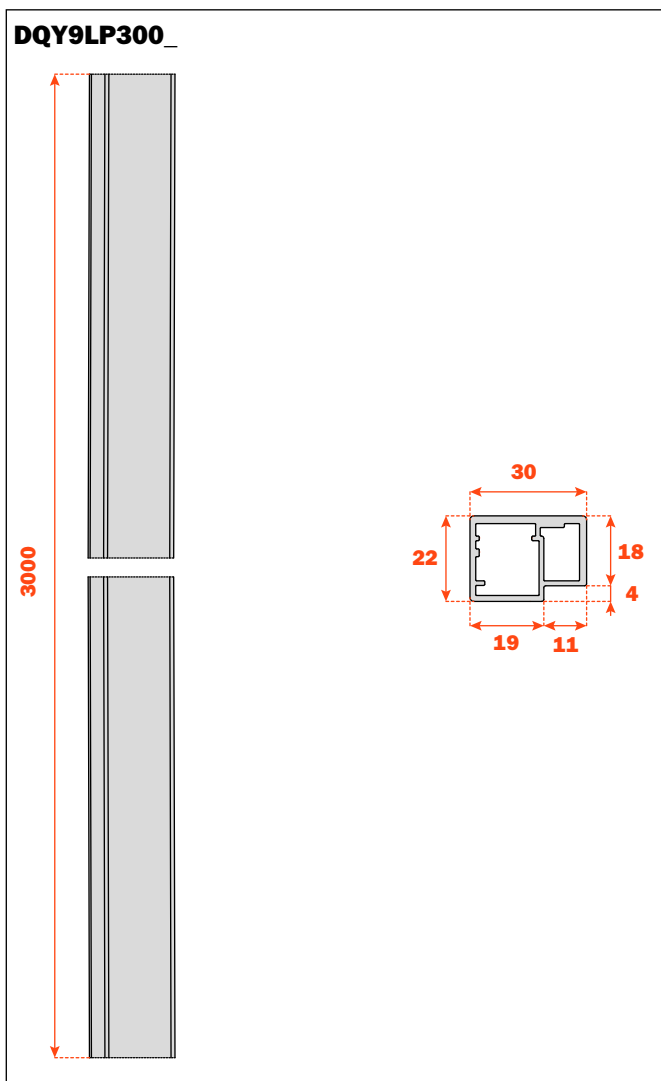
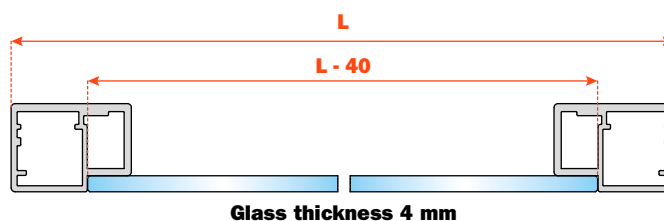

ARTURO SALICE S.p.A.

VIA PROVINCIALE NOVEDRATESE, 10
22060 NOVEDRATE (COMO) ITALIA
TEL. 031 790424 - FAX 031 791508
info.salice@salice.com - www.salice.com

DEUTSCHE SALICE GMBH

RUDOLF DIESEL STR. 10
74382 NECKARWESTHEIM
TEL. 07133 9807-0
FAX. 07133 9807-16
info.salice@deutschesalice.de
www.salice.com

DEUTSCHE SALICE GMBH

VERKAUFSBÜRO NORD
RINGSTRASSE 36/A30 CENTER
32584 LÖHNE
TEL. 05731 15608-0
FAX. 05731 15608-10
vknord@deutschesalice.de
www.salice.com

SALICE UK LTD.

KINGFISHER WAY
HINCHINGBROOKE BUSINESS PARK
HUNTINGDON CAMBS PE 29 6FN
TEL. 01480 413831
FAX. 01480 451489
info.salice@saliceuk.co.uk
www.salice.com

SALICE FRANCE S.A.R.L.

285 RUE DE GOA ZAC LES 3 MOULINS
06600 ANTIBES
TEL. 0493 330069
FAX. 0493 330141
info.salice@salicefrance.com
www.salice.com

SALICE ESPAÑA, S.L.U.

C/ AIGUAFREDA 4, P.I. AMETLLA PARK
08480 L'AMETLLA DEL VALLÈS (BARCELONA)
TEL. 0034 938 46 88 61
info.salice@saliceespana.es
www.salice.com

SALICE PORTUGAL UNIP. LDA

SHOWROOM:

TV SÁ E MELO 161 FA
4470-116 MAIA - PORTO
TEL: 00351 224 154 221
Info@saliceportugal.pt
www.salice.com

ARMAZÉM:

VIA ROTA DOS MÓVEIS I 399
4585-325 GANDRA

SALICE CHINA (SHANGHAI) CO. LTD.

1st FLOOR, B1 BLDG 928 MINGZHU ROAD
XUJING, QINGPU DISTRICT
SHANGHAI 201702 - CHINA
TEL. 021 3988 9880
FAX. 021 3988 9882
info.salice@salicechina.com
www.salicechina.com

SALICE INDIA PVT. LTD.

1001 & 1002, 10TH FLOOR,
CENTRUM, PLOT NO. C-3,
OPP. WAGLE PRABHAG SAMITI OFFICE,
MIDC AREA, WAGLE INDUSTRIAL ESTATE,
THANE - 400604, MAHARASHTRA
TEL. 022 20812050
info@saliceindia.com
www.salice.com

SALICE CANADA INC.

3500 RIDGEWAY DRIVE,
UNIT#1
MISSISSAUGA, ONTARIO, L5L 0B4
TEL. 905 820 8787
FAX. 905 820 7226
info.salice@salicecanada.com
www.salicecanada.com

SALICE AMERICA INC.

2123 CROWN CENTRE DRIVE
CHARLOTTE NC. 28227
TEL. 704 841 7810
FAX. 704 841 7808
info.salice@saliceamerica.com
www.saliceamerica.com

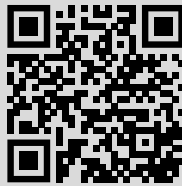

Digital contents